

AMANO®

TCX-45

Atomic Time Clock

Operation Manual



Proprietary Notice

This document contains proprietary information and such information may not be reproduced in whole or part without the written permission from Amano Cincinnati, Inc. 140 Harrison Ave., Roseland, New Jersey 07068.

Amano Cincinnati, Inc. reserves the right to make equipment changes and improvements, which may not be reflected in this document. Portions of this document may have been updated to include the latest hardware or firmware version, if applicable. We recommend that this document be read in its entirety before any attempt is made to operate the equipment.

Thank You....

For purchasing another fine product from
Amano Cincinnati, Inc.



Important! Do not return this clock to the retailer. If you have any questions or need assistance, please call us toll free at 1-800-253-9836

Need Ribbons, Keys and Accessories?
Visit
www.amano.com
Or call 1-800-253-9836

Warranty Notice

Any claim for warranty, express or implied, due to the clock's failure to properly receive the radio signal because of interference, whatever may be the source of this interference, are hereby expressly excluded.

For more information about the WWVB-Radio signal visit NIST's website at:
www.boulder.nist.gov

For actual signal coverage in North America visit:
www.boulder.nist.gov/timefreq/stations/wwvbcoverage.htm

Specifications

Power Requirements

- **For Clock Input:** 16.5 VDC, 60Hz, 0.6A (Max.)
- **For AC Adapter:** 100 VAC \pm 10%, 50/60Hz
120 VAC \pm 10%, 60Hz
230 VAC \pm 10%, 50/60Hz
- **Battery:** Lithium Battery for Memory Backup in case of power failure.

Ambient Temperature: -10°C to 45°C (14°F to 113°F)

Ambient Humidity: 10% to 90% (non-condensing)

Dimensions: 6-11/16"(170 mm) Wide X 6- 7/16"(163 mm) High X 6-5/8"(168 mm) Deep.

Weight: Approximately 3.6 lbs. (1.63 kg)

Environment: Indoor use only; dust-free environment. Keep out of direct sunlight.

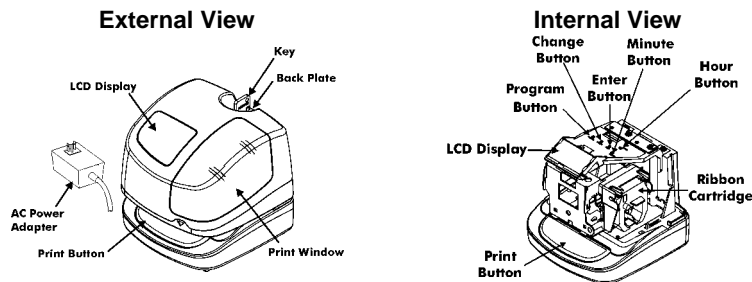

- The **PROGRAM** button is used to enter and exit the Program Mode.
- The **CHANGE** button is used to change the information on the display.
- The **ENTER** button is used to accept the information shown on the display and save it in memory.
- The **HOUR** button advances the hour in the display by increments of 1.
- The **MINUTE** button advances the minutes in the display by increments of 1.

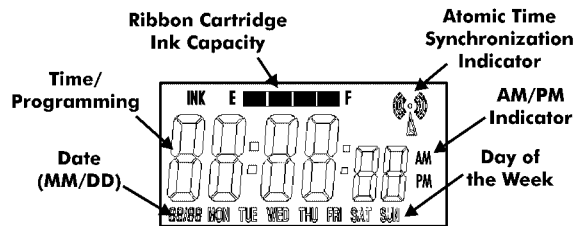

The LCD Display contains an Ink Capacity gauge. This gauge indicates the amount of ink remaining in the ribbon cartridge using four bar segments, from E (Empty) to F (Full).

The TCX-45 calculates the ink capacity of the ribbon cartridge from the number of imprints made. As the ink capacity decreases, the bars in the gauge will disappear. If the ribbon reaches below 25% capacity, the word "INK" will appear. The "E", "F" and "INK" characters will blink until the ribbon is replaced and the ink counter is reset.

Removing the Cover & Packing Material

1. Insert the key provided and turn clockwise to unlock the cover.
2. Lift the cover to remove.
3. Remove the spacer between the Ribbon Cartridge and the Printer Carriage.

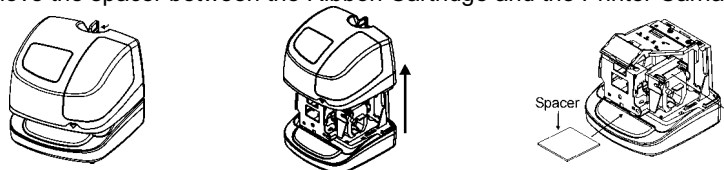

Making a Test Print

1. Make sure the TCX-45 is plugged in.
2. Insert a piece of paper or time card into the TCX-45. The clock will automatically print YEAR, MONTH, DATE and TIME with AM or PM.

'03 DEC 23 8:40PM

3. If the imprint is satisfactory, the TCX-45 is ready for use.

Setting the Time (If Displayed Time is Incorrect or In Different Time Zone)

1. Unlock and remove the cover.
2. Press the HOUR advance button until the correct hour appears.
3. Press the MINUTE advance button until the correct minute appears.

Note: You must follow this procedure if you are installing the TCX-45 in a different Time Zone from where it is currently located.

Changing the Print Style

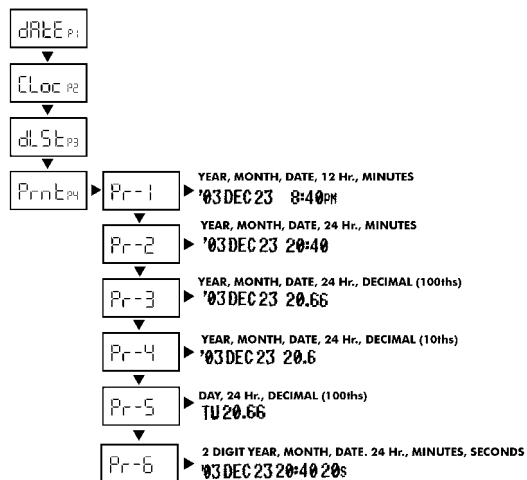

1. Press the PROGRAM button until dRtE P1 appears.
2. Press the CHANGE button until Prnt P4 flashes in the display. Press the ENTER button.
3. The display will flash the current setting. Press the CHANGE button until the desired print style code appears (see diagram).
4. When the display flashes the correct setting, press the ENTER button and press the PROGRAM button to exit.

Changing the Print Direction

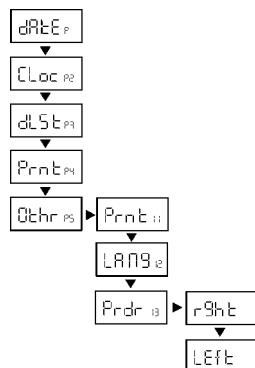

1. Press the PROGRAM button until dRtE P1 appears.
2. Press the CHANGE button until Qlhr P5 flashes in the display. Press the ENTER button.
3. Press the CHANGE button until Prdr P3 flashes in the display. Press the ENTER button.
4. Press the CHANGE button until the correct print direction rShE (Right Side) or LEfE (Left Side) flashes in the display, then press the ENTER button.
5. Press the PROGRAM button to exit.

Disabling Daylight Saving Time

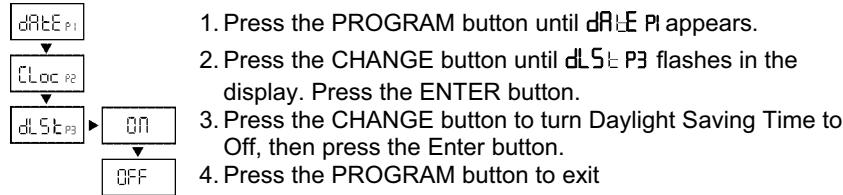

1. Press the PROGRAM button until **dRtE P1** appears.
2. Press the CHANGE button until **dLSt P3** flashes in the display. Press the ENTER button.
3. Press the CHANGE button to turn Daylight Saving Time to Off, then press the Enter button.
4. Press the PROGRAM button to exit

Enabling or Disabling Auto Print

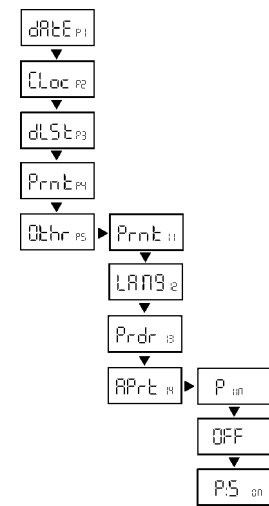

1. Press the PROGRAM button until **dRtE P1** appears.
2. Press the CHANGE button until **Qthr P5** flashes in the display. Press the ENTER button.
3. Press the CHANGE button until **APrt P4** flashes in the display. Press the ENTER button.
4. Press the CHANGE button until the desired code appears on the display, then press the Enter button. The Auto Print codes are as follows:

Code	Mode	Description
P on	Auto Print	Will automatically print a single print when media is inserted.
OFF	Manual Print	Requires you to use the PRINT button when printing.
P5 on	DO NOT USE	

5. Press the PROGRAM button to exit.

Setting the Month and Date

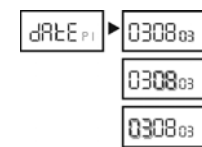

1. Press the PROGRAM button until **dRtE P1** appears, and press the ENTER button.
2. Press the CHANGE button until the correct year appears, then press the ENTER button.
3. Press the CHANGE button until the correct day appears, then press the ENTER button.
4. Press the CHANGE button until the correct month appears, then press the ENTER button.
5. When the display flashes the correct month, date and year, press the ENTER button.
6. Press the PROGRAM button to exit.

Wall Mounting

Placement considerations:

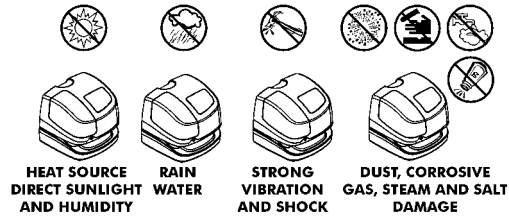

1. Remove the Cover and remove the Back Plate by pressing the tab.
2. Using the Back Plate as a template, mark the lower mounting hole on the wall.
3. Mount the plate using a #10 wood screw (or equivalent).
4. Level the Back Plate and mark the location of the two upper mounting holes. Secure to the wall using #10 wood screws (or equivalent).
5. Feed the cable of AC Power Adapter through one of the holes in the Back Plate.
6. Align the clock with the two upper tabs on the back plate. Tilt the back of the clock upwards to fully insert the back plate tabs into the clock. Be careful not to pinch the power cord with the bracket.
7. Once the tabs are inserted, tilt the clock back down and push it against the wall. The tabs will snap into place.
8. Replace the cover and lock it in place.

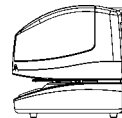
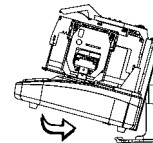
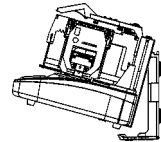
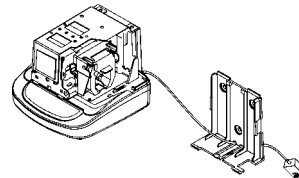
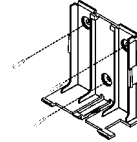
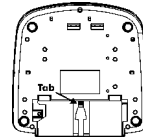

Atomic Clock Feature

The Amano atomic clock receives time signals on long wave radio (60 kHz) from the National Institute of Standards and Technology (NIST) operated WWVB time signal transmitter located in Fort Collins, Colorado and coupled with the atomic cesium clock in Boulder. It receives the WWVB time signal via its built-in antenna system. Your clock will try to find the signal on a daily basis.



The Atomic Time Synchronization Indicator in the LCD Display indicates the status of the signal. When you first receive the clock, it may be necessary to adjust the hour and minute. If your TCX-45 is located in an area that cannot receive the Atomic time signal, DO NOT be concerned.

Searching for Signal **Found Signal**



The TCX-45 will accurately keep the time using its Quartz mechanism (plus or minus three seconds per week).

Please visit to www.boulder.nist.gov/timefreq/stations/radioclocks.htm for more information about how radio-controlled clocks work, where they work, and what to do when they don't work.

Disabling the Atomic Clock

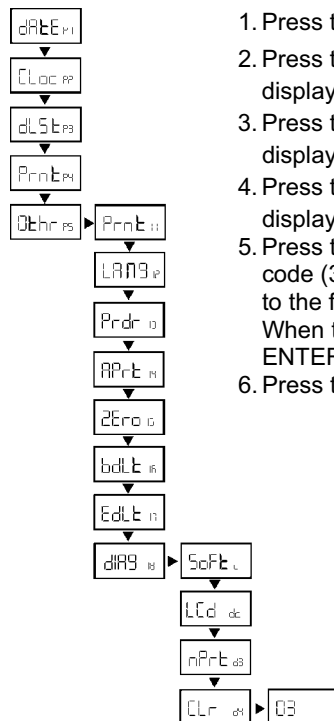

1. Press the PROGRAM button until **dRtE P1** appears.
2. Press the CHANGE button until **CLoc P5** flashes in the display. Press the ENTER button.
3. Press the CHANGE button until **dISt P3** flashes in the display. Press the ENTER button.
4. Press the CHANGE button until **CLr d4** flashes in the display. Press the ENTER button.
5. Press the CHANGE button to enter the last digit of the code (3) and ENTER to accept it. The display will move to the first digit of the code (0). Press ENTER to accept it. When the display flashes the correct code (03), press ENTER.
6. Press the PROGRAM button to exit.

Ribbon Cartridge Replacement

1. Remove the cover.
2. Pull the two ribbon release tabs upward.
3. While holding the release tabs in an upward position, pull the ribbon cassette out of the cradle.
4. If the print mechanism is down and a piece of paper cannot be inserted, unplug the clock, then plug it back in to move the carriage up. This will make the ribbon installation easier.
5. Insert a new ribbon underneath the printer head as shown.
6. Turn the knob on the cassette clockwise one turn to take up any slack in the ribbon.
7. Check the printing quality to confirm that you have installed the ribbon properly.
8. Reset the INK capacity gauge by pressing the CHANGE and ENTER buttons at the same time
9. Replace the cover.

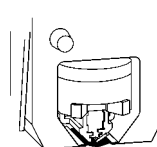
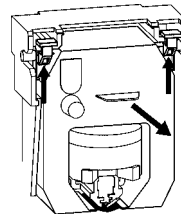

Error Messages

Error Code	Cause
PrE1	Home sensor, motor carriage stuck
PrE2	Timing sensor, carriage stuck
PrE3	Home sensor
PrE4	Carriage stuck
PrEr	General print error
dLE	Daylight Saving Time Program

For error messages PrE1 through PrEr, unplug the clock before checking to see that the carriage is not stuck or jammed. Also, check to see that the ribbon cables are in good condition. After clearing any jams, unplug the clock, then plug it back in. Contact us at 1-800-253-9836 if you need assistance.

The dLE error message signifies that an attempt was made to get into the Program mode during the Daylight Saving changeover one-hour lockout. Wait one hour and you will be able to program the clock.

Cleaning

Do not use any chemical solvents or oils to clean or lubricate your TCX-45. This will damage your clock.

To clean the inside of your clock, blow it out with air.